

UFO

THE TRUTH IS ALREADY HERE

monthly.com

ISSUE NUMBER 40

SEPTEMBER 2007

EAMONN ANSBRO AND HIS UFO TRACKING CAMERAS



ETI MUSIC PART TWO



Optical zoom x20

Available to purchase in the UK and Overseas via
PAYPAL

CONTACT DETAILS

You can contact the magazine by regular mail or by telephoning:

01924 864614

or

07970 364368 (GMT office hours please).

The postal address is:

UFO Monthly.com
8 Ashdene Drive
Crofton
Wakefield WF41PQ

Or by email at:

heseltinegary@hotmail.com

For more information visit the website:

www.ufomonthlymagazine.co.uk

With your help and input my aim is to bring you a low cost quality publication that represents value for money.

GARY HESELTINE Editor

WE ARE NOT ALONE.

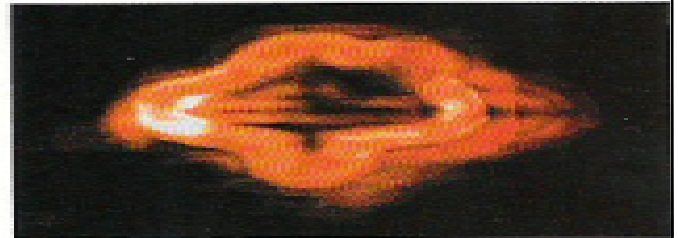
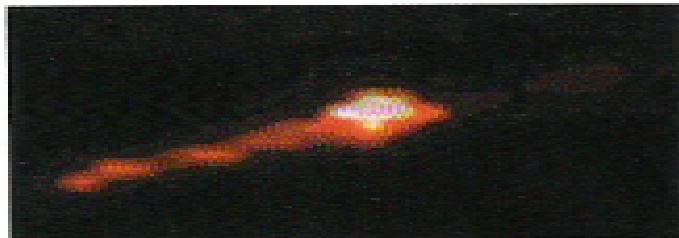
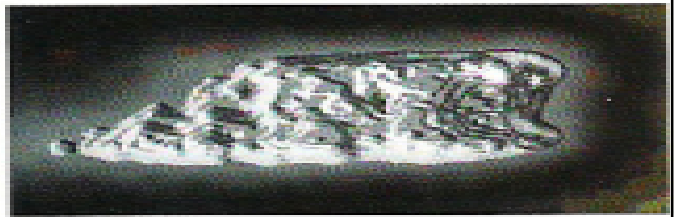
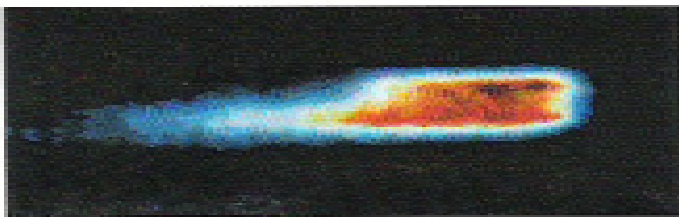

SUBSCRIBE FREE AND LEARN THE TRUTH ON

www.interseti.com



EDITORIAL

Welcome to the 40th issue of UFO Monthly.com. This month we have a series of interesting articles by people who have all contributed to the magazine previously, Eamonn Ansbro, Roger Anderton and James Weller.

Please make a note that the magazine has been published a week early in light of Valerie and I taking a holiday abroad for a couple of weeks. Therefore be patient with any queries re: distribution whilst we are away. Thank you.

On a sad note September marks the 4th Anniversary of the death of Graham Birdsall. This magazine was borne out of his influence on me.

I think of him often. **GH.**

CONTENTS

4. Eamonn Ansbro brings us up to date with the latest developments in his pursuit of the perfect UFO camera tracking system.



8. Sound waves and ETI Music from Space by Roger Anderton.

12. A round up of the all the latest sightings from around the UK.

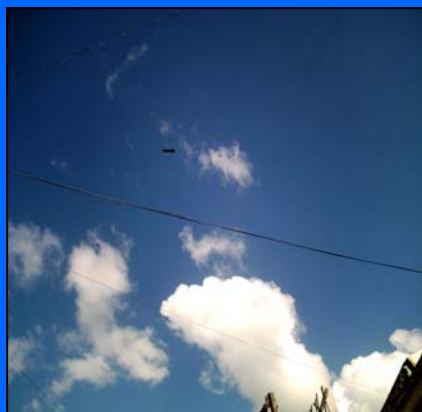

17. The latest UFO sightings from around the world.



22. Public Reaction to the UFO Phenomenon: A Brief Investigation of the Stratford UFO sighting by James Weller.

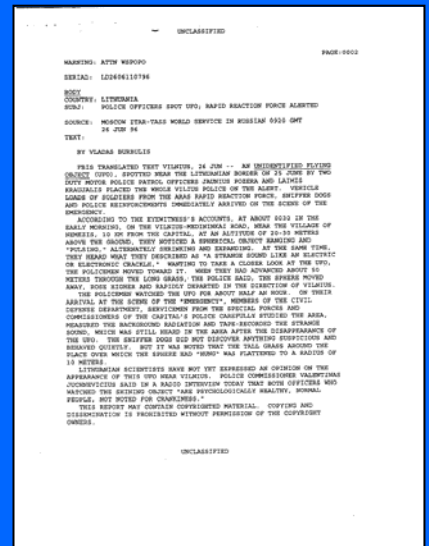

26. UFOs and the Web. Interesting tidbits from around the web.

30. Two more documents to add to your UFO archive collection.

Enjoy the magazine. **GH.**

Comparitive Video Camera Imaging for UFO Research by Eamonn Ansbro, M.Ast., FRAS

In February and April this year, the European UFO Survey (EUS) in collaboration with Kingsland Imaging Systems carried out successful tests of two new video camera systems specifically designed for imaging UFOs.

The EUS is a Swiss-based NGO made up of scientists from 10 countries within the EU. One of the EUS goals is to encourage the use of better camera equipment by researchers throughout Europe.

The reason for this emphasis is clear to anyone who has seen the typical blurry images of a UFO. When ordinary equipment is used, the image resolution is often so poor that even sophisticated software programs cannot bring out more detail.

As a result, it is difficult to get useful scientific data. Blurry, poor-quality images cannot be analysed to reveal more structural detail, or to discover physical characteristics such as size, speed and distance, or to get information on chemical composition and electrical discharge which could reveal information about propulsion mechanisms. Better quality images will be able to provide scientists with data of scientific value. For example, it could shed light on whether propulsion mechanisms such as magneto-hydrodynamics (MHD) are being used.

The European UFO Survey (EUS) was eager to assist UFO researchers in obtaining images that would be of scientific value. They approached Kingsland

Imaging Systems because of their familiarity with a wide range of astronomy and optical equipment, and because of their familiarity with the challenges posed by the UFO phenomena.

This often involved moving objects at a long distance and poor light conditions. EUS asked Kingsland to develop a sophisticated video camera system that would capture better quality images yet cost no more than €3000 in total—a challenging task. The result of this challenge was Kingsland's Discovery 1. This was later followed by IR-1, which images in the Near Infrared.

The EUS decided to use active UFO areas in France to try out the new instrumentation. On 10 February 2007 the EUS conducted tests in Brest, and on 21 April, 2007 the EUS conducted tests in Vence near Nice.

In Venice the team went to a mountainous area at a height of 1200m where there was known UFO activity. To put the new video camera systems through their paces, clusters of helium-filled balloons were launched during a 6-hour testing programme. Simultaneous observations took place using both the Discovery 1 camera (which operates in the visible) and the new infrared camera called IR1 (which operates in the Near Infrared). It was possible to get images with good resolution at a long distance and in close-ups on both cameras.

All those present were

impressed by the superior resolution of the Kingsland Imaging Systems equipment.

It was a dramatic difference from the images obtained from commercial camcorders and still cameras EUS members had brought for comparison. The equipment's stability and effectiveness was impressive, even in adverse weather conditions such as gale-force winds and lashing rain at Brest.

After the success of the new tracking cameras the EUS has plans for further tests in Boyle, County Roscommon, Ireland during June and July. This area has had significant sightings down the years. Even as recently as May and June a number of UFOs have been seen. This location is an obvious choice because the frequency of UFO sightings seems to be above normal.

Comparison: Discovery 1 and Camcorder.

Preliminary comparison tests with a better-than-average Sony Handycam DCR-DVD91E highlight Discovery 1's long-distance, high-resolution capabilities. These tests show the limitations of conventional commercial equipment. While camcorders can give good acceptable results at relatively close range (up to 100 m), at longer distances they are useless at capturing any detail at all. In contrast, Discovery 1 can capture images even when they are many kilometres away.

Some raw images—not processed in any way—will make

this difference obvious. Kingsland decided to use a "UFO SAM Kite" to carry out some tests. This is a kite consisting of 4 "wings" that rotate in the wind around a central axis. Its wings are covered with reflective mylar.

Its width across is 50 cm. Here's a sketch of the kite, and an actual image taken with Discovery 1 when the kite was spinning at about 10 rotations per second, at a height of about 30 meters:

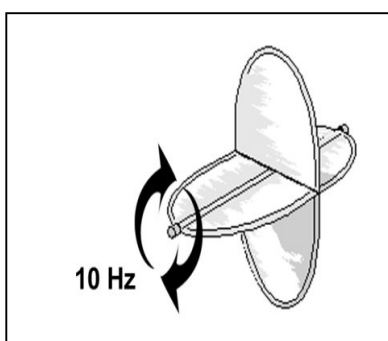

[Figure 0-A: "UFO SAM Kite" diagram]



[Figure 0-B: spinning "UFO SAM Kite" at 30 m imaged by Discovery 1]

At this extremely close range, a conventional camcorder also functioned well. Next the distance was increased to approx. 200 meters. Even at this short distance, and with the camcorder using its full zoom capability, it is no match for the Discovery 1.

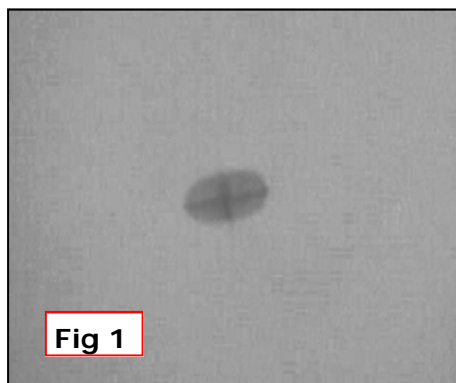

[Figure 1: Discovery 1 image of "UFO SAM Kite" at 200 m]

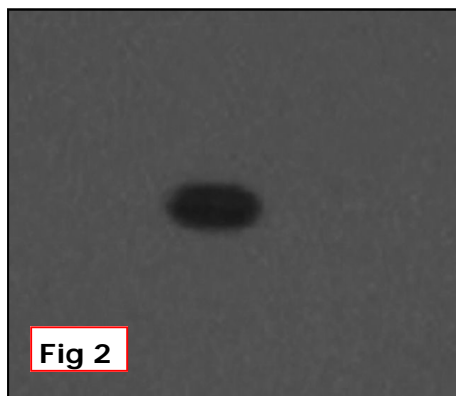

[Figure 2: Camcorder image of "UFO SAM Kite" at 200m]

The difference in image quality is for several reasons: Camcorders mostly rely on digital zoom, which doesn't give good results at distances greater than 200 m. Discovery 1 uses special lenses that give optical zoom, resulting in a better quality image even at a range of several kilometres. Camcorder frame refresh speeds are not quick enough to accurately capture a fast-moving object (e.g., the spinning UFO SAM Kite in the above picture); but the fast frame refresh rate of Discovery 1 makes it possible to capture a clear image of a moving target.

Camcorder sensors—even on better-quality camcorders such as the one used above—have pixels that are not as sensitive as the pixels on Discovery 1. Not all pixels are the same size or the same depth. Some pixels

(such as those on Discovery 1) have a larger micron size create a bigger, deeper "light bucket" and therefore have greater sensitivity and give a better quality image which is sharp and full of rich detail. Now let's compare some images taken at a longer distance. Kingsland Imaging Systems decided to attempt to image some wind generators on the horizon, at a distance of 12 kilometres. On the day in question, the cloudy weather made it hard to see the masts with the naked eye, because there was so little contrast with the colour of the clouds in the background. In fact, the camcorder could only pick up an unfocused hint of the wind turbine masts, even at full zoom. With Discovery 1, however, even in these challenging conditions, the masts and turbine blades could be clearly distinguished and identified:

[Figure 3: Discovery 1 image of wind turbines at 12km distance]

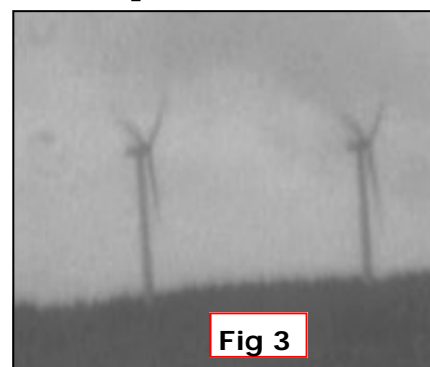

[Figure 4: Camcorder image of wind turbines at 12 km distance, full zoom]

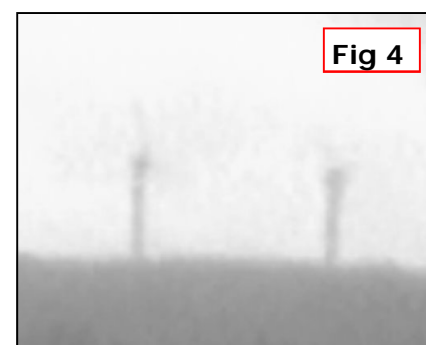

The higher resolution of Discovery 1 means that professional image processing software (e.g., Mirametrics) could be used to carry out scientific analysis and to reveal even more detail. With the camcorder images this would not be possible, since it couldn't pick up the distant objects at all.

Further comparison tests will be carried out this summer at the National University of Ireland Applied Optics Department, which will also show the image improvements that are possible when sophisticated image processing is combined with high-quality optical systems.

Infrared Imaging – Discovery 1 Developing camera systems with capability of imaging in the Near Infrared was a key goal of EUS and Kingsland Imaging Systems. The reason is that some scientists speculate that more UFOs may be visible in the infrared than in the visible wavelengths which the human eye can see. The famous Mexican UFO footage by aircrew of 2004, shown on the main news on North American and European television channels, was taken with military infrared FLIR cameras on board an aircraft. This was a good example of imaging UFOs in the infrared spectrum.

Conventional commercial cameras and video cameras have been designed for the visible spectrum. Visible light has wavelengths ranging from roughly 400 to 700nm (1nm = 10⁻⁹m). So why are UFOs sometimes captured only on very expensive military-type cameras? One explanation might be that some UFOs are emitting light in the infrared part of the spectrum which don't show up in the visible region.

This means that some UFOs may be invisible to the naked eye,

and suggests that UFOs are operating at infrared frequencies as well as (or instead of) visible frequencies.

A number of researchers believe that there may be ten times more UFOs showing up in the infrared than the visible region. Infrared light is often divided into three different "bands": near, mid, and far infrared. For infrared photography imaging, it is typically the Near Infrared band that is detected (approximately 700nm to 1200 nm). Discovery 1 is particularly sensitive in the visible and through 900nm. However, Discovery 1 quantum efficiency is about 90 percent as compared to 1 per cent for infrared film cameras.

Kingsland has carried out some preliminary Near Infrared tests with Discovery 1, which has good sensitivity in the Near Infrared. For the test a red LED light was attached to the bottom of a spinning "UFO SAM Kite" in night conditions at a distance of 150m. The images below were recorded simultaneously using Discovery 1 and the same camcorder as before. You'll notice that only Discovery 1 could get an image. Even in "NightShot" mode, the camcorder could not pick up anything at all. In some frames there was just a dot of faint light—if you look closely perhaps you can see it.



Fig 5

Figure 5: Discovery1 Near Infrared capability: "UFO SAM Kite" and red light at

150m at night.

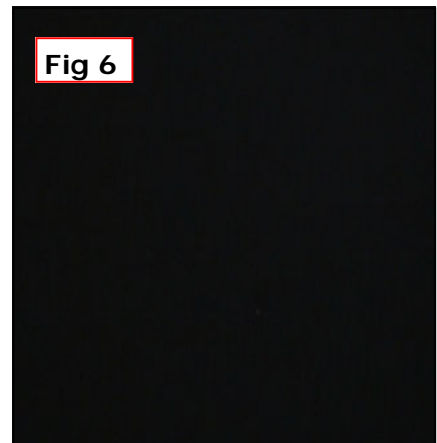

Fig 6

Figure6: Camcorder UFO Kite and red light at 150m in "NightShot" mode at night.

Even at a fairly close range, the HandyCam cannot keep up with the sensitivity of Discovery 1. The camcorder—even though it has "Night Shot" for low light levels, was not able to record any image at all. Infrared Imaging and IR-1. Because EUS was particularly eager to have special equipment for the Infrared, Kingsland Imaging System also developed a system that would focus exclusively on the Near Infrared, in order to provide more scientific information. The sensor in the IR-1 is specially designed for the Near Infrared, being even more sensitive than Discovery 1 in the range from 700 to 1200 nm.

An interesting experiment in night conditions, using a small candle beside an infrared (invisible) emitting remote control device used for operating a television set. The IR-1 picks up both small light sources, even at a distance of 80 m. Notice the flame's teardrop shape is accurately recorded as well as the pin-point light of the TV remote control.

The camcorder, however, even in "NightShot" mode, could not pick up the infrared light at all.

It barely captures the flame, but only an indistinct, unfocused

amorphous blob despite all efforts to get a better focus.

[Figure 7: IR-1 image of infrared light and candle flame at 80m]

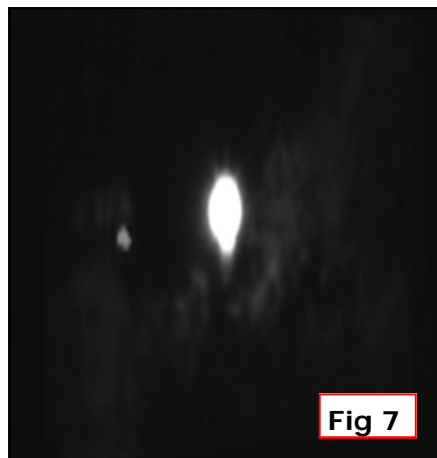
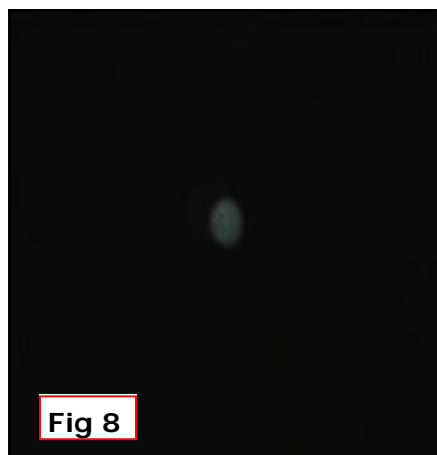

Figure 8: Camcorder image of infrared light and candle flame at 80m—note that the infrared light does not register at all, and the candle flame is unfocused.

Kingsland looks forward to the



future tests at NUI Galway using special infrared light sources and longer distances. It is expected that the difference between IR-1 and conventional camcorder at longer distances will be at least as dramatic as that shown above with Discovery 1.

Next Steps: Simultaneous Imaging Using Both Visual and Infrared Systems.

These new imaging systems can be combined to provide simultaneous recordings of

images in both the visible and invisible Near Infrared ranges. This creates a higher chance of capturing UFO images with greater scientific information.

Figure 9: Dual Camera System

A dual camera system such



as this could provide scientific evidence that UFOs are operating in both the visible and the infrared. Imaging carried out by Pedro Avila in Mexico of UFOs in both visible and Infrared suggests that the UFOs show up in the infrared and transition to the visible and vice versa.

If he had better quality equipment to work with his images would be more useful to the scientific community. Perhaps they may use some sort of propulsion system that can go through a sequence of frequencies that can be primarily in the infrared at some times and at other times in the visible. This opens up a whole new field of UFO research of imaging by the those wanting to explore this new vista.

It is also possible for a single controller to control up to 5 cameras at the same time. When simultaneous recordings

are obtained different cameras in different locations, scientific information about distance, size, and speed can be reliably calculated.

EUS and Kingsland Imaging Systems hope that these new advances in optical equipment will make it possible for scientists and members of the public to contribute to UFO research. New discoveries will be made when the right equipment is used.

About the Author:

Eamonn Ansbro, M.Ast., FRAS, is the Director of Kingsland Observatory in County Roscommon, Ireland. In 1976 he discovered a new star, *Nova Volpecula 1976*. He was also the co-discoverer of a hydrogen envelope around the rings in Saturn, and of Moonquakes later confirmed by NASA.

As Managing Director of Optiglas Ireland Ltd he manufactured high-quality industrial optics for industrial applications including pollution control equipment.

As Director of Kingsland Observatory he is undertaking a survey of the distribution of Edgeworth-Kuiper Belt Objects (EKBOs) and is looking for the location of a new planet with collaborators on the faculty of the Planetary Space Science Research Institute (Open University, UK).

EDITORIAL COMMENT

Yet again Eamonn has delivered another excellent and fascinating article. Thank you. I look forward to the day he takes the 'dream photo' using his imaging systems. **GH.**

Sound waves and ETI Music from Space by Roger Anderton

This is a follow-up to my article in issue 38 of UFO Monthly on ETI Music being detected from space.

It is difficult to know where to begin, because there are many mental blind spots. I will cover the background of blind spots at the end of this article.

First I want to deal with the issue of sound in outer space.

1. Natural Music of Space

What is usually taught is that sound waves require a medium such as air, and that sound cannot travel through a vacuum. We are then told outer space is a vacuum, therefore sound cannot travel through outer space. However, this last part is incorrect.

Outer space in reality is not a perfect vacuum: it has rarefied gas, actually ionised gas, and through this medium sound can travel, as NASA has discovered.

When people go up high mountains, the air gets less dense, and if people climb high enough they need to take oxygen canisters to breathe. If we go up higher than Mount Everest, into outer space, the air becomes thinner and thinner, but never disappears completely; it never becomes a perfect vacuum.

So, where many have been taught in science classes that outer space is a vacuum, that has been wrong. There is enough gas for sound to travel in; of course we need devices to listen to this sound and cannot do so by the unaided

ear. If we were to be in outer space unprotected by space craft or space suit of course we would die. The gas in outer space is so low pressure that we would explode.

NASA has made the discovery that there is sound in outer space, and it is not widely known. Certain sounds they deem musical, but actually these are natural sounds. The sounds that were detected from Gliese 581C were intelligent in that they showed patterns.

NASA's discovery was announced at Science Daily on 22 Oct 2002 with the title "NASA Music Out of this world." The source of the news was NASA/Jet Propulsion Laboratory.

<http://www.sciencedaily.com/releases/2002/10/021025070109.htm>

The article starts:

"With scientific instruments on NASA's Voyagers, Galileo, Cassini and more than two dozen other spacecraft, University of Iowa physicist Dr. Don Gurnett has been recording waves that course through the thin, electrically charged gas pervading the near-vacuum of outer space."

Note that it refers to outer space as "near-vacuum" not "vacuum"; it is their way of overcoming the difficulty that many have been taught outer space is a vacuum; instead, they now say "near-vacuum" and that waves travel through this electrically charged gas.

There is, of course, a philosophical issue here. We

are used to receiving sound through air in our daily lives, but we are not used to sound through the electrically charged gas of outer space; so the philosophical issue is a question of whether the word "sound" is appropriate in the latter case. This question of semantics could of course be endlessly argued.

I accept that the word "sound" is appropriate; at least what we get from our devices gets turned into sound that we can hear in our usual medium—the air we breathe—as dealt with in the article as it continues:

"Gurnett converted the recorded plasma waves into sounds, much as a receiver turns radio waves into sound waves. 'I've got a cardboard box full of cassette tapes of sounds that I've collected over nearly 40 years,' he said."

Donald Gurnett has his website at:

<http://www-pw.physics.uiowa.edu/~dag/>

On it there are such things as a lecture, and a collection of sounds that you can hear which have *Kronos* now incorporate this into their act, because these sounds are deemed musical to some extent.

This issue of sound being discovered in outer space probably is a rediscovery dating back to at least the Germans in World War II, with their radar and radio experiments. What NASA has as sounds should be compared to what has been received from Gliebeen received from outer space.

Sounds include lightning at Saturn, sound from the solar wind, sounds of the magnetosphere etc.

A group of musicians called Iese 581C because it is different; it's a pattern, which I attach so you can listen to it and notice the difference between this and what are natural sounds of space.

Now, onto the issue of mental blind spots:

I have been in contact with the astronomer who placed the ETI music from Gliese 581C at the SETI website and then removed it. Unfortunately, he is a person who has been taught that outer space is a vacuum, and so believes sound cannot travel through it, hence the issue of sound in space he thinks nonsense, and dismisses the music from Gliese 581C as something that can be ignored.

This is a mental blind spot on his part. Undoubtedly there are others who do the same, and ignore looking at the issue of music signals from ETI civilisations when they conduct their radio astronomical investigations.

That is, when they receive a bit of music from space their mental blind spot causes them to just ignore it.

2. Unified Field Theory

We live in a Society where there are people of many different beliefs in conflict with each other.

Music has been detected from outer space. The proper way of understanding this is from the Unified Field Theory. I say this because one of the things the UFT is supposed to deal with is the interaction of the different types of waves; and in this music issue it is the

interaction between different waves in ionised gas, electromagnetism and so forth.

Einstein was supposed to be looking for the Unified Field Theory and never found it. However, I researched the subject and the literature shows otherwise.

The theory has a large part of its origins with Pythagoras and his "Music of the Spheres" – the music from space is an indication of intelligence, and should be understood from that perspective.

The Unified Field Theory is a subject mostly ignored by mainstream science, but I can point to the scientists that were dealing with it: Bohm, Bertrand Rusell, Boscovich, Whyte, Baranski, Watson, et al.

The split in the UFO community is between the believers and sceptics; this covers a whole range of different beliefs ranging from the complete believer who might be part of a religious cult to the complete sceptic who believes nothing, and in the middle between these extremes are those people who don't know one way or the other.

Once the chaff is removed, what we are left with is evidence for ET. However, there are people uncomfortable with this idea, and when it comes to the evidence they want to ignore it. The range of what these people want to ignore includes the Unified Field Theory.

We thus live in a world where there are a great deal of mental blind spots. Galileo faced the same problem in his era; he presented the astronomical evidence and there were many who wanted to ignore it.

Similarly, there is now astronomical evidence for ET and there are people who want to

ignore it.

Different people have different blind spots, so whatever has to be said has to address whatever blind spot a person has, and since there are so many, where to begin?

We live in a society where there are many beliefs in conflict and we have to try to live together and respect other people's beliefs even if we do not agree with them. There are many different points of view, not one single dominant one.

Of course, mainstream science tries to present itself as the only viewpoint for scientific ideas, leaving those who don't want to believe those ideas to conclude that they must reject science altogether, and the mainstream science community often tries to give the impression that anything which they do not believe is not scientific, but instead some sort of religious belief or pseudo-science.

However, like politics, with its different parties, there are often different scientific viewpoints within different scientific groups. And, as in politics, a dominant party likes to smear its rivals.

On the issue of Einstein there have been several ideas associated with relativity and quantum theories that some people have had difficulty in accepting. This has usually resulted in the split into two parties: those pro-Einstein and those anti-Einstein.

As we might expect, the mainstream science community is pro-Einstein and the alternative science community is generally anti-Einstein. However, to say that the mainstream community is pro-Einstein is not absolutely true; there are ideas that the mainstream community accepts by Einstein and there are ideas by him that they do not accept.

While the alternative science community in my experience tends to be very anti-Einstein, they generally take the position that no matter what Einstein says it must be wrong. Between these two warring factions what usually gets lost is what Einstein and his associates were researching in Einstein's later years.

The alternative community generally takes the position that whatever Einstein was working on was wrong, so they decide to ignore whatever Einstein was working on in his later years. To the mainstream community, Einstein's later work tends to be an embarrassment and they try to ignore it because it does not seem to fit with what they like to believe is Einstein; i.e. they want to have

the young Einstein as authority for their science and ignore the older Einstein.

So, what was Einstein working on in his later years? Answer: The Unified Field Theory, of course.

Now, many in the mainstream want to credit this theory solely to Einstein, and not to believe otherwise.

But, those working with Einstein on the Unified Field Theory show that it has a much longer history from before Einstein, going back at least to ideas of Pythagoras.

It is a very large chunk of scientific endeavour that is being ignored by many. And of course Pythagoras deals with such issues as the *Music of the*

Spheres.

In outer space sound waves travel, and they often have what is deemed a musical quality to them; this should be a very simple and easy idea to understand, but many have deluded themselves into believing it is not possible. Similarly, Unified Field Theory is fairly simple, being based in large part on Newtonian physics, but many have deluded themselves on this as well.

Some of these sounds are natural music of the planets, while others demonstrate active intelligence. But science's blind spots, prevent many scientists from recognising this.

c.RJAnderton2007

SPECIAL CD COLLECTION



UFO MONTHLY.COM IS NOW AVAILABLE TO COLLECT IN SPECIAL YEARLY PRESENTATION CASES COMPLETE WITH LABEL AND COVER. EACH CD CONTAINS TWELVE ISSUES (1-12/13-24/25-36). ALL ARE AVAILABLE AT THE SPECIAL PRICE OF £12 (INCLUDING POSTAGE AND PACKAGING—UK ONLY). PAYPAL AVAILABLE VIA THE WEBSITE.

THE 4TH IRISH UFO CONFERENCE

The Fourth Irish International UFO Conference takes place on 22nd/23rd September 2007 at the Bush Hotel, Carrick-on-Shannon, Co. Leitrim.

The Bush Hotel is an ideal venue with a state-of-the art Conference room and Carrick-on-Shannon is easily accessible, being on the main train line and bus route from Dublin. As always we have a great line up of Speakers coming from America, Italy, England, Ireland and Wales. The predominant theme this year tends to be towards the more spiritual aspect of the UFO phenomena, with presentations on hypnosis, regressions, orbs and the like. It promises to be perhaps the most interesting Conference to date - and you won't know, unless you are there! Certainly the last three have proved to be immensely successful and there is no doubt but that this one will be equally so.

BETTY MEYLER

Just to remind you that the Travel/ Accommodation Agent is Una Bhan Tourism Co-operative, King House, Boyle, Co. Roscommon, tel: +353 (0)7196 63033, email: unabhan@indigo.ie, www.unabhan.net.

2007 SPEAKERS



PAOLA HARRIS (ITALY)



ELLIS TAYLOR (UK)



JANE McCARTHY (UK)



BREEGE WALSH (IRL)

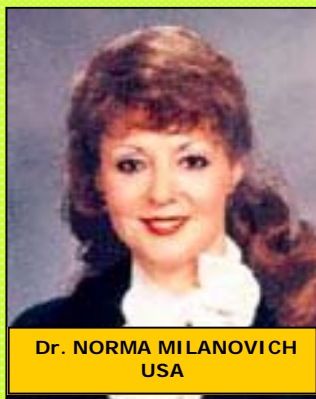

Dr. NORMA MILANOVICH
USA



YVONNE SMITH (U.S.A.)



DAVID COGGINS (U.K.)



MALCOLM ROBINSON (UK)





August 2nd 2007 North Devon, England

North Devon, U.K. A Blue - Silver Sphere

Date: August 2, 2007

Time: Approx: 4.30 p.m.

Location of Sighting: Back garden at home.

Number of witnesses: 1

Number of objects: 2

Shape of objects: Spheres.

Full Description of event/sighting: Hi Brian, Although I emailed you about my sighting earlier today, just after it happened in fact. I thought that maybe I should have completed this form.

At about 4.30pm today I was in my back garden playing around with a new digital camera my husband bought me a couple days ago. I was looking around for things to photograph and thought I'd take some photos of the birds etc, I had a thought that it would be great if I could see a UFO and take a photo of it (I swear this is true!!) just after I had thought this, I was looking up into the sky and to my absolute amazement I noticed a blue/silver sphere in the sky in an easterly direction.

I was amazed I just stood there looking up at it when it seemed to either get bigger or nearer, I then saw a second identical smaller sphere appear to the left of the larger sphere, the smaller sphere hung there for about a minute then disappeared, the larger one stayed there, I was trying to take photos of it. I still haven't got the hang of using the zoom yet and so just kept aiming it and hoping for the best that I'd get a photo of it.

The larger sphere after hanging there for a few minutes then

started moving on towards the east at a higher altitude, then disappeared from sight. The



whole sighting lasted approx 4 - 5 minutes. I then went back indoors as quickly as I could to email you Brian, next I downloaded the photos from my camera, which on first inspection seemed that I had not managed to get a picture of what I'd seen, however, on closer inspection I could see that in fact I did get a picture of one of the spheres, later in the evening I was able to actually enlarge the photo and could very clearly see the sphere.

Click image for full size
Brian It's me again, look very closely at photo number 2 (almost top centre ! - THERE IT IS ! I just spotted it - I'm so excited, and NO it wasn't dust on my monitor screen, study them closely please. [UFOINFO Note: Only photo 2 has been used as that is the only one showing the sphere.]

Thank you to the witness for the

report and photos. The photos are copyright 2007 to the owner.

August 3rd 2007 Patcham, Brighton, East Sussex, England

Location: Patcham, Brighton, East Sussex, England

Date: 08/03/07 22:45 GMT

Approach Direction: South to North East

Departure Direction: North Easterly

Witness Direction: South

Description: I spotted at least 4 spherical objects in the sky to the South, the objects appeared to be moving slowly from South to North East. The objects changed their formation on several occasions before being obscured by houses to the North.

Colour/Shape: Redish purple, spherical objects, object moved to form various formations. NB. I managed to take a couple of photos using a handheld digicam although they are not that great due to the long

exposure.

Height & Speed: 200-5000ft, slow moving objects, took about 10 mins to move from horizon to disappearing behind houses to the North.

August 4th 2007 Brantham, Manningtree, Essex, England

Location: Brantham, Manningtree, Essex, UK

Date: 4/8/07 2230 approx

Approach Direction: north

Departure Direction: east

Witness Direction: south

Description: A bright light that looked like a bright star was heading toward me in a straight line. It was dark but its motion was straight but almost seemed that occasionally buffeted by the wind its direction seemed to gradually veer east but without any sudden change of direction.

It headed away east and then it was almost as though the light went out and it was gone, it didn't speed off it just wasn't there any more. There are a lot of planes and helicopter traffic in my area but they can all be identified as such by flashing lights and noise but this had neither. It was like nothing I've seen before and I couldn't say what it was or wasn't, I called my son who tried to film it on his phone but without success.

Colour/Shape: If it hadn't been moving I would said it was a bright star.

Witness update:

I've had a look at the footage of the balloons. It is possible that what I saw was one of these but I think unlikely as the light I saw was a white light. The balloons have a much more yellow tint as the light in created by a naked flame.

[UFOINFO thanks the witness for the follow-up report.]

August 5th 2007 Croydon, Surrey, England

Croydon, Surrey A Round White Object (UFO)

Date: August 5, 2007

Time: Approx: midday.

Location of Sighting: Shirley Road, Croydon.

Number of witnesses: 2

Number of objects: 1

Shape of objects: Oval.

Full Description of

event/sighting: I was at a Garden Centre in Shirley Road Croydon with my girlfriend on Sunday at around midday. I was standing with our trolley whilst my girlfriend was looking at plants in the outdoor part of the garden centre. I was looking west and noticed a round white object travelling north.

At first I thought it was a plane or helicopter, however, the more I looked at it, the more I realized that there were no wings or any features. It was just a plain white oval object. The speed at which it was travelling told me that it wasn't a balloon either. I estimate from the distance I was from it, that it was larger and travelling faster than a passenger plane. I pointed it out to my girlfriend who was more interested in the plants so I didn't get much of a response. I lost sight of it when it went behind some flats immediately next to the garden centre.

This is the second object I have seen recently. A couple of months ago, a red orb passed at speed during the day directly over my garden in Addiscombe Croydon. At first from I distance I thought it was a balloon, but the speed that it was travelling at and its straight line trajectory made me think twice. It came over quite low and I could tell it definitely wasn't a balloon.

I have studied the UFO phenomena since I saw a

fantastic UFO as a child and I'm always looking to the skies. These are the first 2 objects I have seen in years that I cannot explain.

August 5th/7th/9th 2007 Bradford, West Yorkshire, England

Location: Bradford, England, United Kingdom

Date: 5/8/07 at 9.00pm and 10.30pm, 7/8/07 at 11.00pm and 09/08/07 at 10.45pm

Approach Direction: From South West

Departure Direction: Towards North East

Witness Direction: Looking towards South West

Description: At 9.00pm on 5/8 as I opened my kitchen door, I saw a very large bright white light in the sky above a nearby warehouse, it grew in size then disappeared. As it was a clear night myself and my daughter went outside at about 10.00pm to watch the sky to see if we saw anything else.

At approx 10.30pm what we had thought was a bright star, as it had been stationary for a while, suddenly moved upwards and started travelling in a north easterly direction. It was very bright and appeared to be quite low in the sky. It moved quite fast and then seemed to disappear rather than travel into the distance.

On the following nights 7/8 and 9/8 as we had decided to watch the sky again, we saw the same light. As we live near an airport and see planes quite regularly, I am certain that this was not a plane, there was no noise whatsoever. There was no flashing, just a brilliant bright white light. On all 3 occasions it came from the exact same direction and travelled in the same direction.

Colour/Shape: Bright, brilliant

White light. No noise whatsoever.
Height & Speed: At a guess several hundred feet high, Regarding the speed, I would guess about 100mph.

August 10th 2007 Chatham, Kent, England

Location: Chatham, Kent, England.
Date: 08/10/07 gmt (21:40 British Summer Time)
Approach Direction: Northwest
Departure Direction: Southeast
Witness Direction: Northwest...
Looking at Ursa Major
Description: I was stood out on my balcony, letting dog out for a!, I love looking at the stars and tonight was clear... I looked to my right and saw the plough (Ursa Major).. well the tail of it anyway.. then, I spotted three objects, they were orange/brown glowing objects moving fast across the sky.

They were swapping positions with each other as if they were having a race or playing a game. I know this sounds bizarre but I could not believe my eyes! I see a lot of aeroplane traffic over this region on-route for London but this was different, very different.

Colour/Shape: the objects appeared diamond in shape, flat to the sky. They gave off a orange/brown glow with a haze around them.

Height & Speed: I have no idea. They appeared bigger than a star, and moved faster than a plane. their swapping motion was at an unbelievable rate. Nothing normal could move in such a way.

TV/Radio/Press: n/a... I have only come to this sight to see if anyone else has spotted a similar occurrence.

August 10th 2007 Tooting, London, England

Location: Tooting, South West London, UK
Date: Friday, 10th Aug at 5.45pm GMT 08/10/07
Approach Direction: zig-zagging from left to right
Departure Direction: Towards the Mitcham direction
Witness Direction: Towards Crystal Palace.
Description: I was walking down Robinson Rd SW19 at 5.45pm on Friday 10th Aug 07 in the direction of Mitcham. It was a bright sunny day with some light cloud in the sky. I saw what I first thought was an aeroplane flying ahead of me towards the right. Next it changed direction and flew left.

It was then I noticed it was not a plane as it had no wings but was a white or light grey oval shaped object. It flew from left to right and back again 5 or 6 times but sometimes disappearing in the clouds. I was with my boyfriend but by the time I realised it wasn't a plane and asked him to look it was too late and he didn't get to see it. The sky was very bright with very little cloud so I can understand why he didn't see it as it was difficult for me to point it out with no markers to use. It disappeared out of my sight over a roof in the direction of Mitcham. This is the second time I've seen a UFO, I saw something totally different one dark evening on 15th Feb 06 and since then am quite observant when out but I never thought I'd see something in broad daylight. The next strange thing is that approximately 5 minutes later a large dark helicopter went by in the same area where I saw the UFO which made me think that maybe the military were aware that there was a UFO about and were out looking for it.

Colour/Shape: White or light grey oval shaped object. Quite bright. Height & Speed: The height is difficult to judge but quite high and it was faster than a plane.
TV/Radio/Press: No.

August 11th 2007 Petersfield, Hampshire, England

Location: Petersfield, Hampshire,
Date: 08/11/07 22.45 (British Summer Time) approx
Approach Direction: East
Departure Direction: West
Witness Direction: East
Description: My wife and I were sitting on reclining chairs in our garden so as to comfortably watch the August Perseid meteor shower. We had been gazing upwards for about three quarters of an hour, looking north-eastwards. Both of us clearly saw the craft move slowly above and to one side of us (north) parallel to our rear garden hedge. We have never seen a UFO before, and it has taken us 2 hours to find this site to report it (as we thought we should after discussion - it being so unusual). We are professional working people in our mid-50s. We also took time to look at stealth aircraft on the internet (due to this craft's lack of noise and shape), but their shapes (although similar) are not the same.

Colour/Shape: Isosceles triangle shape, silhouetted (black) against clear night sky. Steady dim, large yellowish lights in each of the 3 corners, possibly striped.
Height & Speed: Slow speed, apparently low. Silent - no noise. Passed over in approx 3 seconds.

TV/Radio/Press: Not known - too early.

August 12th 2007 Wakefield, West Yorkshire, England

Sometime around 00:30
Approach Direction: East
Departure Direction: West
Witness Direction: West
Description:

There are 5 of us laid down on a trampoline looking at the August Meteor's, we started at about 23:00 and stopped at around 01:30.

We see plenty of Meteors, planes and satellites. Then somebody says 'can you see that', then all of us gasp, then fall silent, we know this is unusual.

There were 2 objects, shaped like chevrons (<), orange coloured and generally flying in a westerly direction with intent, although one was dancing around a bit as if playing/enjoying the ride.

They were faster than a plane/satellite, but slower than a meteor, and very graceful. I considered that maybe they were part of a meteor that skimmed on the earth's atmosphere, but no, they were 'piloted' objects.

We couldn't see any outlines of the shapes, just the orange chevrons. There were no noise, and no other objects near at the time. As an engineer and sceptic I can't rationalise an explanation for what we saw, the flight pattern and profile were unlike anything I've ever seen.

It was a clear night sky, a new moon, so dark skies with plenty of stars. Being the peak of the August Perseids meteor showers, there must have been more observers who saw this.
Colour/Shape: Orange chevron <
Height & Speed: Much faster than planes, satellites, slower than a meteor. Height maybe same as an high altitude plane.

TV/Radio/Press: not aware of

any.

August 13th 2007 Hackney, London

Location: England. East London Hackney.

Date: 8/13/07. 2.30am
Approach Direction: West
Departure Direction: East
Witness Direction: Looking directly up.

Description: Me my brother and my two sisters were sitting over the park watching the meteor shower from around 1.30am. We were all looking in different places of the sky directly above us.

We had already seen a few meteors. Then around 2.30am my brother spotted something very different he shouted 'what's that' pointing at the object.

We all saw it, it was a dim yellow egg shape with no trail and no sound moving very fast from west to east (opposite to the meteors) but no way as fast as a meteor and at the end it quickly turned left to right very sharply and very early.

Because we are in the city we had a circle of sky with stars and on the outside of the circle it was really bright this is where we lost visual.

We were absolutely stunned with what we all saw, I could not believe what I had seen. I was very freaked out shouting and stuff.

I have always heard of sightings from people I know and said I wouldn't believe until I saw one with my own two eyes. Well now I have.

Colour/Shape: Dim Yellow. Egg shape.
Height & Speed: Consistent speed. Couple of thousand feet.

3 times as fast as a commercial jumbo jet.

August 13th 2007 Nuneaton, Warwickshire

Location: Nuneaton, Warwickshire.

Date: 08/13/07 12:45am GMT
Approach Direction: west
Departure Direction: east
Witness Direction: east
Description: My wife and I were watching the meteor shower that had been reported on the local radio station. It was a very clear night and we had seen several meteors.

We were distracted by something moving quite slowly directly above us, it was an object with two very bright white lights, about the size of a large star but moving slowly and not in a straight line.

It seemed to be wobbling. After watching it for approx two minutes it suddenly disappeared!

It had no flashing lights so we ruled out it being a plane. It seemed too high for a plane too.

We had seen several planes taking off from our local airport approx 15 miles away throughout the evening and nothing compared.

Colour/Shape: very bright white. Two round lights next to each other.

Height & Speed: It wasn't travelling as fast as a plane. It was very high, we were watching planes going over for a while, it wasn't a plane.

All sightings courtesy of UFOINFO and Brian Vike, Director of HBCC Research.



STRANGE PHENOMENA INVESTIGATIONS CROYDON LECTURE PROGRAMME FOR 2007

For the first time ever in Surrey, a series of regular monthly lectures on ghosts, poltergeists, UFOs and the paranormal is coming to **Croydon, Surrey**.

You will be able to listen to the UK's 'top' UFO & Paranormal researchers discuss a whole range of weird and wonderful phenomenon. This is 'your' opportunity to come along each month and learn all about strange phenomena and indeed perhaps relate your own paranormal experience (if you have one).

DATE	SPEAKER	SUBJECT TITLE
Saturday July 14 th	Malcolm Robinson	UFOs, Ghosts And The Paranormal'
Saturday August 4 th	Nick Pope.	'The Real X Files'
Saturday September 29 th	Marcus Allen	'Did We Really Land On The Moon' ?
Saturday October 13 th	To Be Confirmed	
Saturday November 3 rd	Ian Franklin	The Ghosts Of Hampton Court
Saturday December 1 st	Professor Chris French	The Psychology of Anomalous Experiences

We hope to see many new faces at our increasingly popular monthly lecture programme during 2007, so do please come along, you will be more than welcome. Indeed, bring along a friend.

All lectures will be held at the Spread Eagle Pub 39-41 Katherine Street, Croydon, Surrey, England

All lectures commence at 3:00pm and conclude at 6:30pm.

Nearest Main Line Train Stations: East Croydon & West Croydon (10-15 mins walk away)

Public: £5:00 SPI Members: £4:00.

SPI cannot be held responsible for the cancellation of a speaker, should this occur, (and we get advance notice in time,) we will ensure an alternative speaker is arranged. These meetings are designed for people with interests in strange phenomena who wish to find out more about the strange world of the unexplained. Join like-minded individuals who share this fascination for all things weird and wonderful.

Join in the after lecture debate and find out about all the latest research. Please note that the views expressed by our guest speakers may not necessarily reflect those of SPI as a whole.

For more information on these meetings, call Malcolm Robinson on 07949 178 835, or e-mail him at:

malckyspi@yahoo.com

SUPPORT BRITISH UFO & PARANORMAL RESEARCH

THE BIG PICTURE: WORLDWIDE UFO SIGHTINGS

AUSTRALIA August 3rd 2007 Greenwell Point, South Coast, New South Wales

UFOINFO Sighting Form Report
Location: Greenwell point
Date: 3rd of August, 2007,
between 10pm and 11 pm
Approach Direction: 1 object
appeared to be dropping down
from sky at high speed.
Departure Direction:
disappeared once below treeline.
Witness Direction: 2 witnesses
facing west.
Description: When driving I saw
at from distance a bright light in
the night sky fall (without
wavering) directly down at
immense high speeds, it then
disappeared and I did not see it
again.

Colour/Shape: bright light, very
very fast!
Height & Speed: Uncertain but
defintiely was exceptionally fast!
TV/Radio/Press: Not to my
knowledge.

CANADA August 3rd 2007 Bells Lake, Grey County, near Markdale, Ontario

UFOINFO Sighting Form Report
Location: Bells Lake / Grey
County / 6 KM due West of
Markdale Ontario, Canada
80 44 12 W 44 18 25 N
Date: 08/03/07 9:30 pm est.
Approach Direction: South
Departure Direction: East
Witness Direction: South
Description: My wife and I
were paddling our Kayaks on

Bells Lake. It was just starting
to get dark and I was watching
the sky for the first stars of the
evening. I was looking at Jupiter
when suddenly I saw a very
bright object rising to the South
West of the Planet. After about
30 seconds of observation I
pointed out to my wife that it
may be the ISS.

It was about the same
inclination, brightness and
speed. After watching it for a
couple of minutes the object
was not moving fast enough to
be the ISS. It began to slow as
it continued North/North East. I
was in shock, I am an avid
armature (armchair) Satellite
fan and have been watching the
sky for decades.

There were the usual high flying
aircraft in the sky but this object
wasn't one of them. I am use to
seeing interesting reflections
off the high flyers at low sun
angles but this object wasn't
one of them. The object
continued to rise until it was
about 70 degrees in elevation
due South then it turned towards
the east, now my jaw dropped,
as it headed east it accelerated.

The luminance when it
approached from the South,
then went East didn't change ...
bizarre! I watched it until it
dropped over the tree line.
I know it wasn't an aircraft, I
know it wasn't a Satellite in
orbit!

I think it may have been a
weather balloon catching a
different air current or it may
have been a launch!

Colour/Shape: Bright white light,
didn't change luminance much.
My wife saw spikes. I saw a
spike pointing down as it
moved over the horizon to the
east.

Height & Speed: Height
approach, 500 Km. Speed
20,000 Kmh at first. Slowing to ?
then speeding up to 20,000 Kmh
as it dropped over the Eastern
Horizon.

TV/Radio/Press: No but it should
be!

August 3rd 2007 : Brome Lake
Area, West Bolton, Quebec

West Bolton, Quebec (Brome Lake Area) A Perfectly Round White Light

Date: August 3, 2007
Time: 9:00 - 9:30 p.m.
Location of Sighting: West
Bolton, Qc (Brome Lake area).
Number of witnesses: 3
Number of objects: Many.
Shape of objects: One round,
some undetermined.
Full Description of event/
sighting: Hi Brian, a friend and
I were spending some time with
my brother at his country home.
Sometime around 9:00 pm we
stepped outside to take a look
at the sky, there were thunder-
storm warnings and we were
curious about how they were
shaping up.

We found that we were
surrounded by gigantic storm
clouds that took a horseshoe
shape around us, we were sitting
in a very still air mass with the
storm clouds many miles away

in all directions.

It was a storm like none of us have ever seen, the lightning was contained within the clouds, mostly running horizontally over incredible distances. There was even a bright red ball that followed the top of the cloud formation from left to right, then returned to the left and disappeared. I know that these atmospheric phenomena are easily explainable, it was what we saw next that really caught our attention.

We noticed that there were quite a few aircraft that seemed to be flying close to the top of the cloud formation to the north, the sky was very dark but we could see their red and white lights flashing. They would fly over the storm towards the east then return to where they started, I think there might have been three of them at one time. Remember, we're watching this from at least 20 miles away.

The next thing we saw was the strangest. The sky above us was perfectly clear, when we looked directly above our heads we saw a bright white light travelling towards the east. It was perfectly round, it almost looked like a cool white light bulb taking a straight path through the sky. Then we noticed the airplane that was following it on exactly the same path, probably about 3 seconds behind it.

We discussed it to try to determine their altitude, the plane seemed to be around 1/2 inch from wingtip to wingtip at arm's length. This led us to believe that they were only a couple of thousand feet above us. The round light was at least as big as the plane following it. By the time the white light entered the cloud bank and disappeared, the plane had fallen way behind, it disappeared about 10 seconds later.

I tried to get footage with my video camera, I was able to catch a lot of the lightning inside the cloud bank but the sky was too dark to capture the smaller objects, I couldn't see anything in my viewfinder while trying to film the white ball and its escort. By the way, American military aircraft regularly fly over this area when they're travelling from the Plattsburgh air force base to the Maine base.

Brian Vike, Director HBCC UFO Research.

August 7th 2007 Ste-Marie De Kent, New Brunswick

Ste-Marie De Kent, New Brunswick Hovering Object Shines Orange Light
Date: August 7, 2007
Time: Midnight/1:00 a.m.
Location of Sighting: My backyard, St-Joseph Rd.
Number of witnesses: 3
Number of objects: 3
Shape of objects: Balls of light.

Full Description of event/ sighting: This was the night of August 7th, 2007. It was about midnight or 1:00 a.m. when I was upstairs. I looked outside and immediately I saw this flying object in my backyard. It wasn't in my backyard, but it was viewable from it, but it was very far. I observed it for a couple minutes as it hovered above some trees. Its lights blinked several different colours. I wasn't sure what it was.

So I asked my girlfriend if she could come upstairs and see this thing, at first, she didn't believe me. But I showed her, and we both observed this object. It blinked, hovered. Then all of a sudden, it shone a very bright orange light. It did this a few times, then started to move very slowly to the left.

We went outside and into my

backyard, where there were no lights so it made it very easy to observe the sky. It was a cloudless night, with all the stars visible.

The object flew to the left very slowly, then stopped, lowered, and started going to the right again. Then it stopped at the exact same place as it started. Then, we saw another object come in. It started to fly towards the first object.

They were the same size and shape. We also noticed another thing: The red lights blinked at the exact same time. The first object flew even further to the right, raised itself. Flew behind some trees and disappeared. The second object stopped, lowered itself, and started to fly to the right as well. It disappeared.

Brian Vike, Director HBCC UFO Research.

August 11th West Of The City Of Lethbridge, Alberta

West Of The City Of Lethbridge, Alberta Bright Light Turns Red
Date: August 11, 2007
Time: 12:30 a.m.
Location of Sighting: West of the City of Lethbridge.
Number of witnesses: 4
Number of objects: 1
Shape of objects: Round - Looked like a headlight then went red and dim.

Full Description of event/ sighting: During the early morning hours of August 11, 2007 at approximately 12:30 a.m. I was standing outside the Lethbridge Lodge Hotel. An extremely bright light, high in the sky caught my attention. I remember thinking, "that's odd, a plane with a spot light on it". The object had no flashing lights, moved unusually slow and resembled that of a giant headlight. This object was

extremely bright and appeared to be very high in the sky (approx 20,000 feet).

As I faced west looking approx 45 degrees in the sky, the object was travelling directly at me in an easterly direction, again, at a very slow rate of speed. As the object got closer I thought it to be about half the size of a full moon whilst high in the sky. The object then came to a stop made a 90 degree turn to the left (north) and travelled at the same slow speed in that direction.

After travelling North for approx 10 to 15 seconds the bright light began to fade slowly then turned a very bright red colour, then back to white and then disappeared while still travelling north. Shortly before and after seeing this bright light, I did see several falling stars. This bright object that I saw in the sky did not in anyway shape of form resemble a falling star. Stars fall or shoot. This was travelling very slow and had no flashing lights. Shortly after the sighting I was joined by a co-worker.

I said to him, "you wouldn't believe what I just saw!", he said. "What, the bright light in the sky". I said "ya, you saw it too." He said yes, him and 2 other friends were watching it as well. Before saying anything to him about what exactly I saw, I asked him to describe to me what he saw. He described exactly what I saw, including the "red" colour and the brightness.

CHANNEL ISLANDS August 13th 2007 St Helier, Jersey

Location: ***** Road, St Helier, Jersey, Channel Islands
Date: approx between 11.00 and 11.30pm, Sunday, 13-08-07
Approach Direction: Coming

from the south heading north
Departure Direction: north
Witness Direction: north
Description: My friend and I were sat in my garden watching the stars and all of a sudden a large triangular shaped object appeared. When i say large, I mean a good 4 times bigger than any of the planes we'd seen in the sky tonight. It was clearly triangular, and although very high in the sky, you could make out 3 or maybe 4 circular lights running down each side, with another 3 going through the middle.

The lights were white and flashed but unlike any we'd seen on the planes tonight. as we had been watching shooting stars and planes we could gauge that this object was travelling far quicker than a plane. it was clearly visible (there was no cloud coverage) and we watched it for a good few minutes before it disappeared. Did anyone else witness this?

Colour/Shape: triangular, with lights running down each side and also thru the middle.
Height & Speed: no idea of height, but higher far than any of the planes we saw.

TV/Radio/Press: Only saw this about an hour ago so don't know!

MEXICO August 4th/5th Mexico City

The Journal of Hispanic Ufology
August 13, 2007
Source: www.analuisacid.com
Date: August 10, 2007
Reports from Airliner Personnel
By Ana Luisa Cid
According to information provided by researcher Alfonso Salazar, aviation technician Domingo Caballero observed three objects having a metallic appearance on Sunday, August 5, 2007 at 12:00 p.m. as they

flew over Mexico City International Airport at an estimated altitude of 10,000 feet. They flew from north to south and displayed an intense glow as they wove in and out of the clouds. Subsequently, two of the objects remained stationary while the third flew away toward the Mount Ajusco region.

Another report is dated August 4, 2007, when the crew of a Boeing 737 flying the Manzanillo-Mexico City route, witnessed an unidentified flying object with the shape of a horseshoe and having a metallic appearance on the San Mateo air corridor (north of Mexico City). The airliner's first officer - who said it was the first time he'd seen a UFO - says that the object remained static next to the air corridor at an approximate altitude of 9000 feet (2700 metres). This happened as they made their approach to MCIA at 5 p.m. and with good visibility. The skies were clear and cloudless.

(Translation (c) 2007.
S. Corrales, IHU. Special thanks to Ana Luisa Cid and Alfonso Salazar)
UFOINFO would like to thank Scott Corrales (Inexplicata & Inexplicata Blog)

PUERTO RICO August 2nd 2007 Guánica

August 7, 2007
SOURCE: ARGUS-PR
DATE: August 2, 2007
Puerto Rico: UFO Sighting Over Guánica
A report received from José A. Martínez of the ARGUS-PR Project.

An Unidentified Flying Object was seen overnight in the town of Guánica on Puerto Rico's southern coast. Several witnesses spending the night at

one of the many beaches in this community, commonly known as "el pueblo de la amistad" (the town of friendship) reported seeing the object from a beach known as El Tamarindo, located near the Copamarina Hotel.

The witnesses numbered some 17 people, some of who were enjoying the cool seaside breeze, others fishing.

At approximately 21:00 hours (9 pm), a strange light reportedly emerged from nowhere, described as a multi-coloured object shaped like a spinning top. Witnesses Maritza Martinez and her husband Geraldo Cuevas contacted this researcher to say that a smaller light emerged from the object and fell into the sea; another witness who did not want to be identified said that this was not the first time that he had seen lights exhibiting similar behaviour, and he had had other experiences as a nocturnal fisherman in the vicinity of the Guánica beach area.

(Translation (c) 2007, IHU. Special thanks to Jose A. Martinez).

USA

August 2nd 2007

Killeen Ft. Hood, Texas

Killeen Ft. Hood, Central Texas
A Steady White Glow (Unknown Object)

Date: August 2, 2007

Time: 9:30 p.m.

Location of Sighting: Killeen/Ft. Hood

Number of witnesses: 3

Number of objects: 2

Shape of objects: ?

Full Description of event/sighting: My husband was standing in our front yard talking to a friend of his. He came in to get me and told me to check it out. I looked up and there was something flying extremely fast. About a minute later another

one followed. My husband told me that I missed the first one.

We live next to Fort Hood army base so we are used to seeing military aircraft. The sky was clear except for a few random clouds. We have watched the space station go over us numerous times and these things moved a lot faster than that. There were no flashing lights just a steady white like glow.

August 5th 2007 Loveland, Colorado

Loveland, Colorado Two
Brilliant White Discs

Date: August 5, 2007

Time: Approx: 12:00 p.m.
(noon)

Location of Sighting: Loveland, CO

Number of witnesses: 2

Number of objects: 2

Shape of objects: 2 Brilliant
White Discs.

Full Description of event/sighting: It was about noon and I went to the truck to get something to drink. Suddenly I saw what appeared to be a white Mylar balloon, but after watching for a few seconds it turned into a brilliant white disc which did some tight circles and loops in slow graceful movements. Then another one appeared literally out of the blue. Now both of them were doing manoeuvres and getting fairly close to each other. It was an amazing sight.

So I called out to the workers to come see the flying saucers. As soon as they started to come out though, one of the objects moved quickly out of view and the other suddenly appeared to turn into a small plane. It was pretty unbelievable.

Luckily however, one of the other supervisors was with me the whole time, saw the whole thing, and reported it to the workers exactly the same way.

You can't imagine how relieved I am that someone else has seen what I have been seeing for the past two weeks. Let me clarify. I didn't see those discs for two weeks, I have seen other unusual aerial phenomena, almost every day, for two weeks straight.

I apologize for not reporting all these incidents. There are so many. Thank you, Brian, for your unwavering support. Any suggestions?

August 11th 2007 Northeastern Pennsylvania

Northeastern, Pennsylvania A
Craft With A Red Pulsating Light

Date: August 11, 2007

Time: Between 11:00pm -
11:30pm

Location of Sighting: Northeast
PA.

Number of witnesses: 3

Number of objects: 1

Shape of objects: Craft red pul-
sating light.

Full Description of event/sighting: Hi Brian, Approximately between 11:00pm - 11:30pm as we were viewing, the star lighted night sky (very clear, no moon) We saw a craft with red lights pulsating which just appeared in front of us about 10 miles away. The craft just appeared at a northwest position and headed towards the southeast we did manage to video tape the craft on a old Sony camcorder night vision.

I just wanted to inform your readers I searched the FAA riding light regulations for aircrafts and this is what I found:

25.1385 Position light system
installation.

(a) General. Each part of each position light system must meet the applicable requirements of

§§25.1387 through 25.1397.

(b) Forward position lights. Forward position lights must consist of a red and a green light spaced laterally as far apart as practicable and installed forward on the airplane so that, with the airplane in the normal flying position, the red light is on the left side and the green light is on the right side. Each light must be approved.

(c) Rear position light. The rear position light must be a white light mounted as far aft as practicable on the tail or on each wing tip, and must be approved.

(d) Light covers and colour filters. Each light cover or colour filter must be at least flame resistant and may not change colour or shape or lose any appreciable light transmission during normal use. (Doc. No. 5066, 29 FR 18291, Dec. 24, 1964, as amended by Amdt. 25-38, 41 FR 55468, Dec. 20, 1976) So if any of the readers out there are seeing anything other than the FAA regulated riding lights make a report.

August 12th 2007 San Rafael, California

A Triangle With Rounded Corners
Date: August 12, 2007
Time: Approx: 11:00 p.m.
Location of Sighting: San Rafael.
Number of witnesses: 2
Number of objects: 1
Shape of objects: Triangle with rounded corners.
Full Description of event/sighting: My girlfriend "J" and I were watching the meteor shower last night on our rooftop patio in downtown San Rafael. We're about 20 miles north of San Francisco and it's a fairly urban area, so light pollution is fairly high. There was no moon, however, so we had a better view of the stars than usual. We were stretched out on two lounge chairs, with a blanket over us. We weren't under the

influence of any drugs, though I had finished about half a pint of Guinness. I had a mini mag' light flashlight with me, and my binoculars. We weren't seeing many meteorites, so out of boredom I had been swinging the flashlight beam around into the sky in big sweeps.

I got up to go to the bathroom, and I got a few steps away when J started yelling "UFO! UFO!" I started looking up and around and a couple seconds later I spotted a dark triangular shape with rounded corners moving quickly across the sky, from approximately north to south, more or less right above us. It had a small red circle in each corner, and was completely silent. I'd estimate that it was about the size of 2 or 3 full moons. I said "hand me the binoculars!, hand me the binoculars!" but was too dumbstruck to look away to grab them, even though J was holding them out to me (her eyes also locked on the triangle). I watched it for about 4 or 5 seconds until it disappeared in the haze of light pollution to the south. I'd say it travelled about 1/8 of the full arc of the sky in the 4 or 5 seconds that I was able to visually track it.

August 13th 2007 Lorain, Ohio

Unusual Manoeuvring UFO
Date: August 13, 2007
Time: Approx. 1:00 a.m.
Number of witnesses: 1
Number of objects: 1
Shape of objects: Unknown.
Full Description of event/sighting: I was on my back deck observing the meteor shower. I was facing east/northeast. At approximately 1:00am, I observed a flashing light coming from the north. I expected it to be an airplane, but it was moving at an extremely high rate of speed, going from north to south in about 3 seconds. It was a very bright, strobe-like light, brighter

than any light on a plane. It moved far faster than any plane, emitting no sound, and much faster than any satellite, which takes a few minutes to cross the sky as well as the fact that satellites don't blink on and off. As it got to the south it stopped and moved back north slightly. Then it did one of two things, being unable to distinguish because of the bright flashing. It moved slightly west and then either (A) did a 360 degree circle back to its original location or (B) did a series of 90 degree moves, moving down, over to the right, up and then left, back to its original location. This move was done in approximately 1-1/2 to 2 seconds. It then moved south again, and I lost sight of it due to a dense tree-line. It moved way too fast to be any man-made aircraft, as well as it is impossible for any man-made craft to do the manoeuvre I observed before losing sight of it. It was not a meteor, moving slower than any meteor I have ever observed, beside the fact I know of no meteor that has ever stopped and reversed its track. It also was not a meteor skipping in and out of the atmosphere, as the flashing had a distinct timed pattern to it. I was ready to dismiss it as "seeing things" until it pulled that last move. I have never observed any object do what this object did (the circle/90 degree moves) in the brief time period it did it in. It's not physically possible for any man-made object to move in the fashion this object did. Because of the briefness of this event (happened in about 10-12 seconds), it was impossible to determine an altitude, although it definitely was not a "tree skimming" height - was definitely much higher than that. Also unable to determine any shape or size of the object.

**All sightings courtesy of
UFOINFO and Brian Vike,
Director of HBCC Research**

Public Reaction to the UFO Phenomenon: A Brief Investigation of the Stratford UFO sighting by James Weller

The Sighting

On Wednesday 25th July 2007, I was browsing through my copy of the *Metro* newspaper when I came across an interesting article entitled 'Town Centre brought to a Halt by Lights in Sky: Avon-calling UFOs.'

Although making the usual *X-Files* and *Independence Day* references, the article outlined quite seriously a mass UFO sighting that occurred on the night of July 21st 2007 in Stratford-upon-Avon. 'More than 100 people' the article claimed, had witnessed five unexplained lights hovering over the town centre for roughly thirty minutes. The article mentioned that photographs of the lights had been taken, as was apparent by the large

picture accompanying the piece. right.

The picture was the first thing to grab my attention. Considering that it was taken using a mobile phone in low light conditions, it was of surprisingly good quality, if a little grainy.

More importantly, the picture did not simply show five blurry lights against a dark background with no frame of reference, as is sadly the case with many UFO images. This picture had multiple witnesses within the frame. A building in the background gave some idea of how low these lights were in the sky, and the lights themselves were quite clearly defined. Four were fixed into an apparent triangular formation on the left side of the picture. The fifth was on the far

The article detailed a few accounts from witnesses of the incident, the specifics of which, including the picture that I have described above, were published in the August edition of *UFO Monthly.com*.

One thing that the article did not mention, however, was that the lights had been captured on film in a short piece of mobile phone footage. This is something that I discovered a few days later.

After reading through the article, my initial impressions were that the 'mysterious' lights were actually released paper lanterns. The only contradictory evidence to this theory was one witness' report that one of the lights



'came hurtling towards the rest at what looked like a very fast speed. But as it neared them it suddenly slowed and stopped altogether.' This intrigued me, but at this point I had not seen the video footage of the lights, and lanterns were still the most likely culprit.

Earlier this year, on 21st April 2007, a friend of mine had excitedly told me that he and his family had witnessed dozens of lights moving slowly across the skies of Sidcup, Kent, the previous night. The lights were visible for at least an hour and he obtained several minutes of footage of them on his mobile phone. He showed me the video, but was disappointed when I explained that lanterns were the most likely explanation for the lights.

After a little digging online later that day, I discovered that a local college had released a few hundred lanterns into the air on the night of the sighting. The mystery was solved, although it took our local paper's online news site a few days to catch up and publish the truth about what the lights actually were.

The footage that my friend had taken was very similar to the picture of the Stratford UFOs. It seemed to me that, once again, lanterns were the likely explanation.

But I wasn't ready to dismiss the sighting just yet, even when a day or so later someone wrote into the *Metro* with the following piece of information: 'We had a wedding on Saturday in Suckley, Worcestershire. At the end of the reception we launched about 20 Thai paper lanterns that were last seen heading off east, towards Stratford, at speed.'

This came after I'd read some (unconfirmed) reports online that lanterns had sailed loose

from a local rugby club in Stratford on the 21st, and that this was the cause of the sighting.

It seems that there were quite a few lanterns flying about Stratford that night, but which ones were responsible for the sighting, if indeed they were responsible, we can only guess.

But as I've said, even with this new information, I didn't want to dismiss the sighting just yet, not with the account of the 'hurtling' light nagging at the back of my mind. So I ventured back online to see if I could uncover more details of the sighting and to see if the lantern explanation could be conclusively confirmed.

What I found was, in many ways, more intriguing and revealing than the sighting itself.

The Reactions

Whenever an article regarding UFOs is published online, the comments left by readers of the article are often a good read. Sometimes uploaded merely minutes after the article, these comments range from simple, humorous remarks, to long drawn out and sometimes quite heated debates on religion and the possibility of the existence of alien life; to even what those of us in the UFO field would probably refer to as some rather 'crackpot' ideas.

When the Stratford UFO sighting made the headlines, the online reactions covered much the same ground. But amongst those comments were some quite interesting reports of other UFO sightings of similar objects across England, taking place before the major sighting in Stratford on the 21st:

(Some of the comments I present here have been edited for length, but not in any way

that alters their original context)

One witness in Doncaster writes:

'I witnessed the same UFOs in the sky above my house on the previous Saturday night, 14th July, at around the same time...my neighbour saw them first and knocked on my door in a panic. Several people outside the local pub also witnessed them.'

Another report of a sighting on the 14th: *'I saw the exact same formation in Leeds on the 14/7/07 at about 7.30pm. It was still light and they glowed red/orange. Kind of footballs in size...I at first thought they were aircraft engines but there was no vapour trail and they hovered no noise, no smoke. I saw one then two...then a third came in to make a triangle. Then they went up into the sky.'*

A report from Hammersmith:

'A few weeks ago my wife and I were on our balcony smoking cigarettes, when I noticed four strange objects flying in the sky. It wasn't that dark so we were able to get a good look. The anomalies were lined up in the same formation as the picture in the Metro.'

One more report, although the location is not known: *'My wife and I saw almost identical lights on July 7th above our garden. No noise, but four lights - very bright. The four lights merged into two after about five minutes, then suddenly blinked out. Gave us a bit of a fright!'*

These comments interested me, especially where people reported lights that were apparently coordinated into a similar formation to the Stratford UFOs. Of course, as I had seen with my friend's sighting on the 20th April, it is not difficult to mistake random groupings of travelling lanterns for an intelligent

formation.

Apart from these few accounts, the other reactions to the sighting could be boiled down to a few different categories. These were the same sort of replies that you might expect to get with any UFO article online. Here are a few of my favourites...

Firstly, you had the generic sceptical remarks : *'Isn't it amazing that for years we have had camcorders, digital cameras, phones with cameras, and no-one has yet come up with a clear, convincing picture of a UFO or aliens?'*

'The vast majority of UFO "sightings" in the UK used to occur just after closing time at the pub. With this Government's approach to 24-hour drinking, it would hardly be surprising to hear of more "sightings" these days.'

'If I'd been there it would have been comforting to have seen RAF fighter jets scrambled to the scene. Just in case it was an "invasion". Naa just a load of drunk nutters.'

Some attempted to point out that UFO does not mean 'alien': *'Of course UFOs exist. By definition they are unidentified flying objects, which just means that the person seeing it cannot identify it. Whether or not they are of alien origin is really what the question should be....'* Unfortunately, these sorts of comments often seem to fall on deaf ears.

There were the usual:

'More seriously, there are billions of planets - what are the odds that we are the only one with intelligent life?' - type of comments.

There are always comments regarding the planetary origin

of the government: *'We don't need to scan the skies for evidence of UFOs.... We have benches full of alien life forms in the Commons and the Lords.'*

And then there are the truly bizarre: *'THERE IS NO OTHER LIFE IN THE UNIVERSE. THIS IS THE ONLY WORLD, WHERE GOD HAS PUT US FOR HIS PURPOSE. UFOs ARE THE WORK OF THE DEVIL AND YOU MUST IGNORE THEM! THEY ARE DEMONS AND WILL DESTROY YOU IF YOU ALLOW THEM.'*

But my personal favourite has to be the simple remark: *'They must have come here to get the latest Harry Potter book.'*

Aside from a few desperate pleas to take the UFO subject more seriously, generally the reaction to UFO sightings and articles online is mostly of the variety presented above. And what this tells me, sadly, is that the public is still grossly uninformed about the UFO phenomenon.

Picking up the Pieces

I think we could all agree that the discontinuation of *UFO Magazine UK* has hit the UFO community hard, not just in this country but around the world. Quite frankly, the mass media have not handled this subject with any degree of the seriousness that it deserves or granted it sufficient attention. The last time I watched a documentary on the UFO subject, I was greeted by a presenter that remarkably pulled statistics out of the air and claimed: 'half of us believe in UFOs and half of those people believe that they walk among us!' As you can imagine, I switched off quite quickly.

People ask where the evidence is. We have the evidence, evidence that proves irrefutably that UFOs exist. But nobody, it

seems, wants to see it! And so their existence is still debated, much to our amusement and disbelief.

I hope that we do get a quality, published magazine back on the shelves, and that it happens sooner rather than later. Because as I have shown with the comments printed above, there is still a lot of confusion and ignorance amongst the general population when it comes to the UFO subject. And with the media doing nothing to educate these people, it falls to the UFO community to do its best to spread the word. I think that the return of a printed UFO Magazine will be a step back on the right track.

I have to salute and support Gary Heseltine, and those others like him who have stepped forward to pick up the pieces that was British ufology following the loss of *UFO Magazine* and start again. We have to salute all those independent investigators, the UFO groups up and down the country who continue to operate, collecting data, and investigating reports. They said ufology was dead, not so long ago, but here we are.

The Stratford UFOs

Returning to the Stratford UFO sighting, a few days after I read the article in the *Metro*, I went online and I watched a three minute video of the lights in the sky. (Take a quick search on Google Video for 'Stratford UFOs' if you want to see it for yourself). Unfortunately, after all I had read and the additional information that had come to light, I cannot conclusively say that these lights were simple lanterns. It is still the most likely explanation, but a few factors call this into question.

Firstly, we have the other UFO reports of similar lights around the same time period. And

secondly, we have the witness' account of one of the lights 'hurtling' across the sky. After watching the video myself, I wouldn't have described the light as 'hurtling' but it does move at sufficient speed to raise an eyebrow or two. What is also unusual about the video is that the four lights in the apparent triangular formation are completely stationary, or at the very least moving incredibly slowly. If these lights were simply lanterns released from a wedding, then why were there only four of them? The report said that at least twenty lanterns had been released – where were all the others? Why were they not also visible in the sky that night?

The fifth light appears on the right side of the video and moves at a fair speed towards the others – was it simply a lantern caught in a different (and faster moving) air current? Was it also simply a coincidence that this 'lantern' was on a direct course towards its stationary companions? And that it then slowed and apparently stopped a short distance away from them? Suddenly, the lantern explanation seems a little difficult to swallow. We can't rule it out, but there is sufficient evidence within the video itself that calls it into question. And therefore, the Stratford UFOs will remain just that – unidentified. Perhaps by the time this article is published a confirmed explanation will have been forthcoming.

But even so, it will hopefully have provided an interesting read and given an insight into how uninformed people still are when it comes to the UFO phenomenon, and how important it is that we continue to educate ourselves and others when the media at large have monumentally failed to cover adequately the greatest mystery

in the history of mankind. Thank you for reading.
© James Weller 2007

EDITORIAL COMMENT

Thank you James for an interesting article on the way the media report sightings. As for the Stratford sighting itself, I too have viewed the video sequence, some ten minutes of mobile video. Given the fact that the group of four lights do not move (this is quite clear against the foreground of people moving

common source of UFO reports but they can only travel in one direction as they are totally governed by the wind. Lanterns cannot stop, hover and hold tight formations for long periods. If this was the only footage of its kind it would have been probably put down to lanterns but this kind of sequence is now becoming increasingly common. For me the Stratford sequence is very reminiscent of the classic six light (11 minute duration) footage taken above the suburban homes of Fleetwood in 2003 which I still believe is

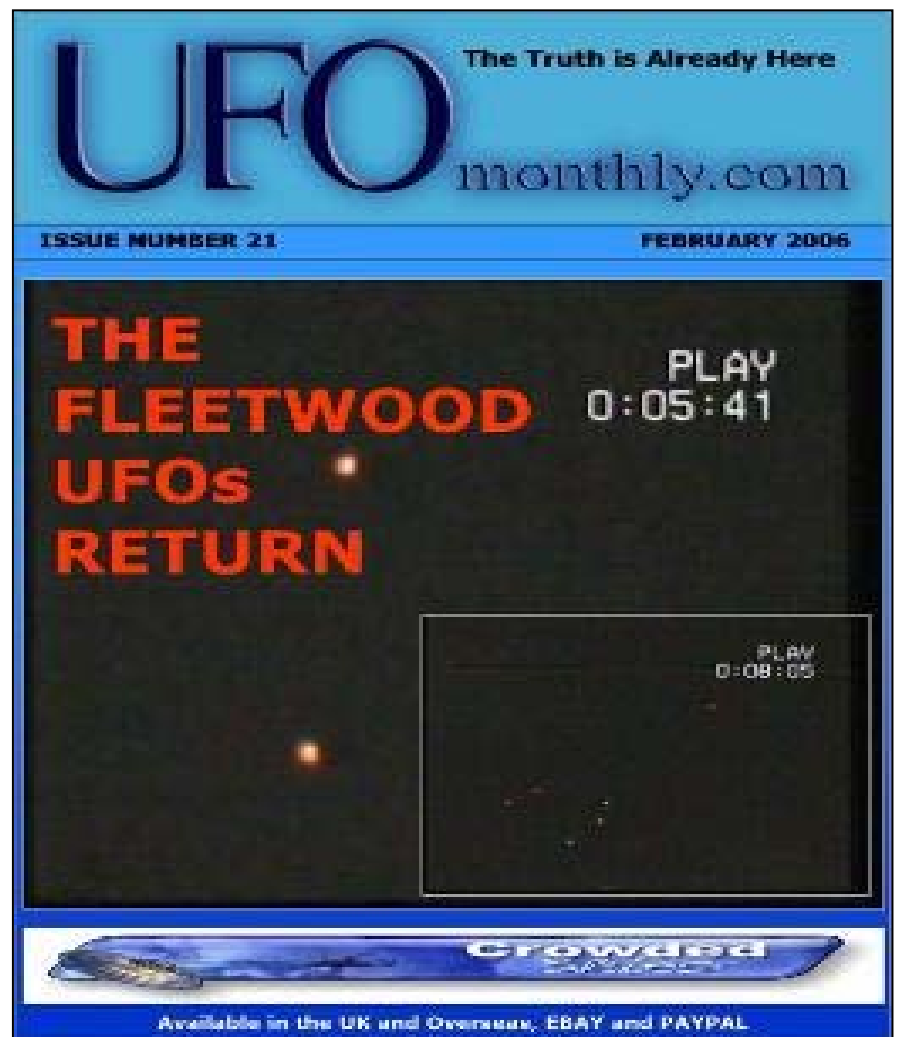

outside the pub) I do not believe the flight characteristics are anything like lanterns. Let us not forget that the actual sighting was listed as around 30 minutes. I believe that if this timing is accurate that would in itself rule out the lantern explanation. Yes, lanterns are now a

one of the best and most important night sequences on record anywhere in the world. No, at this moment in time I would still label the Stratford sequence as genuine UFO footage. Thanks once again for the article James. **GH**

UFOs and the WORLD WIDE WEB

Shuttle STS-117 Spots "Curving" Object

Jeff Challender writes, The primary task of STS-117 was delivery and installation of the S3/S4 Truss Segment and deployment of a new solar array.

During the days' activities on 20 June 2007, one day after undocking from International Space Station, a routine water dump was carried out by the crew of Atlantis. The water dump was shown "live" on NASA Select TV, as allowed by the INCO in Houston Mission Control Center.

The waste water dump is a routine operation performed by Shuttle's on orbit. A water dump is accomplished by spraying excess water out into space through a nozzle. As this water is released, the individual droplets freeze almost instantly into ice particles rather like snowflakes.

They scatter all over, bumping into each other like billiard balls, and even bounce off the Shuttle and Station components. But, due to the principle of inertia, they always move in straight lines through the vacuum of space. Once on a trajectory, they continue in a straight line until being influenced by an outside force such as the firing of the RCS jets aboard the Shuttle.

It can briefly blow small particles about just like the wind on Earth. The gases dissipate into the vacuum rapidly, and their effect is quickly lost. A strange anomaly larger and brighter than any of the others makes a curving course during the shuttle video. The anomaly compared to the ordinary ice particles is apparent. The ice crystals move straight while the anomaly curves through space changing direction.

I believe a good case has been made for this object being anomalous in nature. It has been demonstrated that all the "usual

suspects" are out of the question. Nothing normally encountered in space fits the circumstances and behaviour this thing displayed. Therefore, I must classify it as unknown. Follow this link for the rest of the story:

<http://www.projectprove.com/Arts/117wd/117wd.php>.

Jeff has an interesting article concerning how to detect lens flares that is worth reading. © 2007 Jeff Challender. Project P.R.O.V.E. DVDs Now available at:

<http://www.projectprove.com/>

International Space Station the Accelerator!

Jeff Challender, Director of Project



Prove writes, "The Space Shuttle Atlantis carried a truss segment to the International Space Station Expedition 15. During the US EVA-9 space walk of 23 July 2007, my VCR was running, per usual, recording all the action broadcast by NASA Select TV.

Upon reviewing the tape of the Space Shuttle mission SST-117, I found what may be another anomaly which got past the censors at NASA. What "live" TV we were permitted that day was under the direct control of the CATO in ISS Mission

Control Center, Houston Texas. The object in question seemed to appear from behind the Space Station, as seen from Cosmonaut Yurchikhin's helmet camera. It moved rather slowly, and "blinked" on and off as it went. Then it suddenly accelerated to several times its previous velocity, rapidly disappearing into deep space.

This writer cannot explain such behaviour in conventional terms. When the object was initially noticed, I took it for debris from ISS Commander Yurchikhin's gloves, which he was cleaning off after scraping metal surfaces on the exterior of ISSy. But when it shot off into space almost in the wink of an eye, there could be no further thoughts along those lines.

Bits of debris simply have no means of propulsion, and therefore cannot accelerate like this object did. Ice and debris CAN be pushed to higher speeds by the use of control thrusters on the Russian segment of ISSy, but these are normally disabled when crew members are outside, for safety reasons.

This incident took place on the US portion of the station, and there are no such thrusters on the American modules. Station attitude is regulated by the Control Moment Gyroscope array mounted on the

US side, and they make no exhaust.

There is considerable distortion of the image caused by the "fisheye", or wide-angle, lens in his helmet and this is a still frame of the flying object enlarged 200%. We can see the object, and its behaviour much better this way. The apparent curving trajectory of the object is an optical illusion caused by the fisheye lens of the camera. The anomaly most likely kept a straight line course.

I believe a good case has been made for this object being anomalous in nature. It has been demonstrated that all the "usual suspects" are out of the question. Nothing normally encountered in space fits the circumstances and behaviour this thing displayed. Therefore, I must classify it as unknown. See the actual NASA video at: Thanks to Jeff Challender:

http://www.projectprove.com/Arts/15_9ob/15_9ob.php

Are orbs proof that spirits DO exist?

By Hazel Courteney of the Daily Mail reports, "At first, it seemed no more than a curious coincidence. Professor Klaus Heinemann, a researcher for NASA, the U.S. space agency, was studying a collection of photographs his wife had taken at a gathering of spiritual healers when he noticed that many of them featured the same pale but clearly defined circle of light, like a miniature moon, hovering above some of the subjects.

Like most rational people, he assumed that the pictures were faulty. 'I presumed the circles were due to dust particles, flash anomalies, water particles and so on,' says Prof Heinemann.

After-thought: An orb appeared on this photo taken by Klaus Heinemann. 'But I was sufficiently intrigued that I returned to the room in which the pictures were taken, in the hope of finding an explanation - like a mirror in the background. None was forthcoming.'

Nor could he find any faults with his wife's camera. And as a scientist

with considerable experience in sophisticated microscope techniques - examining matter down to atomic levels of optical resolution - his methods were nothing if not rigorous. Still puzzled, Heinemann set out to discover what else might have caused the mysterious circles.

He and his wife began taking hundreds of digital photographs at random events to see whether they could recreate the mysterious effect.

The answer was that they could make these shimmering 'orbs' appear again, but only - absurd as it may sound - if they 'asked' the apparitions to make themselves visible to the camera. And they found this method worked particularly well when the couple photographed spiritual gatherings. What on earth was going on? Again, a maverick technical glitch seemed the obvious answer.

Such anomalies happen frequently in digital photography. If you accidentally jog a camera while a picture is being taken, especially in dim light, you can easily get a double image. But again, Prof Heinemann ruled out a technical fault.

'We were quickly able to eliminate the common problems associated with photography— such as dust particles, water droplets, reflections and a host of other likely causes.'

Heinemann set up dozens of experiments using two cameras on static tripods under controlled conditions. His early experiments found that orbs can move very fast, up to 500mph or more. Heinemann also found that during his numerous dual camera experiments, when he used twin cameras to capture an object from two different angles, a single orb shape would often appear - but only in one of the two images taken simultaneously.

It was as if the orbs somehow chose which camera to appear on, or whether to appear at all. Eventually, Heinemann was left with only one conclusion: that he was witnessing some form of paranormal intelligence. 'There is no doubt in my mind that the orbs

may well be one of the most significant "outside of this reality" phenomena mankind has ever witnessed,' says Professor Heinemann.

'Until now, there has been a huge amount of anecdotal evidence that the spirit world exists. I believe it's no longer anecdotal.

Thanks to digital technology, we can see it for the first time. We are dealing with a non-physical - albeit real - phenomenon.' "Earlier this year, the world's first conference on orbs took place in Sedona, Arizona, where several scientists controversially stated that they believed orbs were indeed a genuine paranormal phenomenon.

Their conclusions, if correct, could have huge implications on the way we view the universe and our part in it. The experts say that just because something has not yet been scientifically proven, it doesn't mean that it is not real.

Professor William Tiller, a theoretical physicist who spent 35 years researching consciousness and matter at Stanford University in California, reminded the conference that what we see with our physical eyes comprises less than 10 per cent of the known universe.

This is because human vision operates only within a limited range of the electromagnetic spectrum. For instance, we cannot see radio waves, which carry huge amounts of information, yet we know they exist.

http://www.dailymail.co.uk/pages/live/femail/article.html?in_article_id=469849&in_page_id=1879

Thanks to Patty.

All information courtesy of Filer's Files

UFOs IN THE HEADLINES

Real Reporting: On A Real Phenomenon

by Rob Simone

NEW BOOK



**Author Rob Simone releases his explosive new book:
Over 200 pictures of REAL news articles of the most compelling and bizarre UFO cases ever reported from around the world.
LARGE 8 ½ x 11 in. "coffee table" format.**

UFOs in the Headlines: Real Reporting on a Real Phenomenon - author and award-winning media personality Rob Simone, examines the UFO/E.T subject from a journalistic perspective. With over 200 photographs of real newspaper clippings, "**UFOs in the Headlines**" gives a rich overview of the hard-hitting and diverse range of UFO news stories from over 10 countries.

The early critical raves for **UFOs in the Headlines: Real Reporting on a Real Phenomenon** indicate that the book will hold a vast appeal, even for those who have basic understanding of the historical or modern history of UFOs. Lyle Holdalh, Senior Feature Writer for Literary Times Magazine writes: "**This engrossing book is a wonderful reference source with hundreds of real reports spanning from the 1950's to modern day. In addition, you see and read the articles just as they appeared the day it was printed, bringing you into the moment of these amazing news stories. The stunning pictures and artwork makes it a perfect addition to any coffee table.**"

Excerpts:

Author C. Clarke comments on **Paul Trent's** UFO photos and his opinion of E.T. life 1950 - page 15

US Air National Guard **chases UFO to 35,000 ft.** - page 17

4 policemen witness UFO landing near Philadelphia, then examine and **handle the craft!** - page 17

U.S. Air Force fighter jet crashes after Air Command scrambles 3 planes to **intercept UFO travelling 360 mph** - page 28

General Hoyt Vandenberg comments on Air Forces' investigations of UFO caught on radar over atomic energy installations - page 52

The Duke of Edinburgh investigates UFOs from **Buckingham Palace** page 120

Florence, Italy: a soccer match was suspended for half an hour as **15,000 spectators witness** UFO that sprayed a "spider web" spray over the crowd - page 165

Turkish Air Force pilot chases UFO - page 283

ARCHIVE DOCUMENTS

UNCLASSIFIED

PAGE:0001

INQUIRE=DOC35D
ITEM NO=00289316
DTG 261107Z JUN 96
FROM FM FBIS LONDON UK
TO TO RUCWAAA/FBIS RESTON VA
RHDLCNE/CINCUSNAVEUR LONDON UK//N2//
RHEBAAA/DOE WASH DC//NN-30//
RHFPAAA/UTAS RAMSTEIN AB GE//INOW//
RHFTAAA/OSIA EUROPE RHEIN MAIN AB GE
RHHJJAA/JICPAC HONOLULU HI
RHHJJPI/PACOM IDHS HONOLULU HI
RHHMUNA/USCINCPAC HONOLULU HI
RUCBAIC/AIC NORFOLK VA
RUCBAIC/AIC NORFOLK VA//DIIC//
RUCOXAQ/FITRON ONE ZERO ONE//320//
RUCWAAA/FBIS RESTON VA//MIL//
RUDKFMA/STOCKHOLM SWC
RUDKEN/AMEMBASSY COPENHAGEN
RUDKTA/AMEMBASSY TALLINN
RUDKVN/AMEMBASSY VILNIUS
RUDMONI/ONI WASHINGTON DC//2140//
RUDPMAX/FAISA FT BRAGG NC
RUDPWDC/DA AMHS WASHINGTON DC
RUEAIIIS/STORAGE CENTER FBIS RESTON VA
RUEALGX/DEFINTAGENCY WASH DC
RUEADADI/AFOSI IOC BOLLING AFB DC
RUEHC/SECSTATE WASHINGTON DC//INR/CEE//
RUEHHE/AMEMBASSY HELSINKI
RUEHMO/AMEMBASSY MOSCOW
RUEHRA/AMEMBASSY RIGA
RUEHVEN/USMISSION USVIENNA
RUEOAYA/CDR NGIC CHARLOTTESVILLE VA
RUERBFA/CDR2DAD FT HOOD TX//G2 ACE//
RUESFV/FBIS VIENNA AU
RUESFW/FBIS WARSAW PL
RUESMF/FBIS MOSCOW RS
RUETIAV/MPC FT GEO G MEADE MD
RUFDBNEU/CDR USASETAF VICENZA IT//AESE-CMO//
RUFGAID/USCINCEUR INTEL VAIHINGEN GE
RUFOADA/JAC MOLESWORTH RAF MOLESWORTH UK
RUFQBBA/US SURVEY SEC SHAPE BE
RUHBABA/CG III MEF//G-2//
RUWSMXI/AMC INTEL CEN SCOTT AFB IL//INO//
RUWSMXI/USCINCTRANS INTEL CEN SCOTT AFB IL//J2-O/J2-J//
RUWTNOK/HQ USSPACECOM PETERSON AFB CO//POLAD//
RXDBHW/CINCNORTHWEST UAJ
RXFNDA/COMNORTH//JOINTINT//
RXFPPH/SHAPE BE//PIO//
CONTROLS
UNCLAS 3V/LITH CISMIL

UNCLASSIFIED

Approved for Release
Date 11 APR 1997

1

The other day I came across this interesting sighting document from 1996 involving two police officers. These are held on the FBI's own website. Note the long distribution list.

ARCHIVE DOCUMENTS

UNCLASSIFIED

PAGE:0002

WARNING: ATTN WSPPO

SERIAL: LD2606110796

BODY

COUNTRY: LITHUANIA

SUBJ: POLICE OFFICERS SPOT UFO; RAPID REACTION FORCE ALERTED

SOURCE: MOSCOW ITAR-TASS WORLD SERVICE IN RUSSIAN 0920 GMT
26 JUN 96

TEXT:

BY VLADAS BURBULIS

FBIS TRANSLATED TEXT VILNIUS, 26 JUN -- AN UNIDENTIFIED FLYING OBJECT (UFO), SPOTTED NEAR THE LITHUANIAN BORDER ON 25 JUNE BY TWO DUTY MOTOR POLICE PATROL OFFICERS JAUNIUS POZERA AND LAIMIS KRAUJALIS PLACED THE WHOLE VILNIUS POLICE ON THE ALERT. VEHICLE LOADS OF SOLDIERS FROM THE ARAS RAPID REACTION FORCE, SNIFFER DOGS AND POLICE REINFORCEMENTS IMMEDIATELY ARRIVED ON THE SCENE OF THE EMERGENCY.

ACCORDING TO THE EYEWITNESS'S ACCOUNTS, AT ABOUT 0030 IN THE EARLY MORNING, ON THE VILNIUS-MEDININKAI ROAD, NEAR THE VILLAGE OF NEMEZIS, 10 KM FROM THE CAPITAL, AT AN ALTITUDE OF 20-30 METERS ABOVE THE GROUND, THEY NOTICED A SPHERICAL OBJECT HANGING AND "PULSING," ALTERNATELY SHRINKING AND EXPANDING. AT THE SAME TIME, THEY HEARD WHAT THEY DESCRIBED AS "A STRANGE SOUND LIKE AN ELECTRIC OR ELECTRONIC CRACKLE," WANTING TO TAKE A CLOSER LOOK AT THE UFO, THE POLICEMEN MOVED TOWARD IT. WHEN THEY HAD ADVANCED ABOUT 50 METERS THROUGH THE LONG GRASS, THE POLICE SAID, THE SPHERE MOVED AWAY, ROSE HIGHER AND RAPIDLY DEPARTED IN THE DIRECTION OF VILNIUS.

THE POLICEMEN WATCHED THE UFO FOR ABOUT HALF AN HOUR. ON THEIR ARRIVAL AT THE SCENE OF THE "EMERGENCY", MEMBERS OF THE CIVIL DEFENSE DEPARTMENT, SERVICEMEN FROM THE SPECIAL FORCES AND COMMISSIONERS OF THE CAPITAL'S POLICE CAREFULLY STUDIED THE AREA, MEASURED THE BACKGROUND RADIATION AND TAPE-RECORDED THE STRANGE SOUND, WHICH WAS STILL HEARD IN THE AREA AFTER THE DISAPPEARANCE OF THE UFO. THE SNIFFER DOGS DID NOT DISCOVER ANYTHING SUSPICIOUS AND BEHAVED QUIETLY. BUT IT WAS NOTED THAT THE TALL GRASS AROUND THE PLACE OVER WHICH THE SPHERE HAD "HUNG" WAS FLATTENED TO A RADIUS OF 10 METERS.

LITHUANIAN SCIENTISTS HAVE NOT YET EXPRESSED AN OPINION ON THE APPEARANCE OF THIS UFO NEAR VILNIUS. POLICE COMMISSIONER VALENTINAS JUCHNEVICIUS SAID IN A RADIO INTERVIEW TODAY THAT BOTH OFFICERS WHO WATCHED THE SHINING OBJECT "ARE PSYCHOLOGICALLY HEALTHY, NORMAL PEOPLE, NOT NOTED FOR CRANKINESS."

THIS REPORT MAY CONTAIN COPYRIGHTED MATERIAL. COPYING AND DISSEMINATION IS PROHIBITED WITHOUT PERMISSION OF THE COPYRIGHT OWNERS.

UNCLASSIFIED

25 JUNE 1996 VILNIUS, LITHUANIA

PURCHASE INFORMATION

**UFO MONTHLY.COM
CAN BE PURCHASED BY
CHEQUE, POSTAL ORDER
OR THROUGH PAYPAL
VIA THE INTERNET.**

SERVICE DELIVERY

UFO Monthly.com can be obtained in two different ways.

1. As an email attachment.
2. On a CDROM.

SUBSCRIPTIONS

Payment can be made direct by PAYPAL by sending the relevant amount to my **PAYPAL** email account:

heseltinegary@hotmail.com

TARIFFS—UK

UK— Email attachment at £1.50 per issue or 12 months subscription for £18.

UK—CDROM £2.25 per issue or a 12 month subscription of £25.

TARIFFS-OVERSEAS (12 months)

EUROPE—36 EURO

US—\$54

AUSTRALIA—\$68

CANADA-\$68

SOUTH AFRICA— 272.00 RAND

REST OF THE WORLD—\$62

NOTE

**OVERSEAS CUSTOMERS
CAN ONLY OBTAIN THE
EMAIL ATTACHMENT
OPTION FOR
SUBSCRIPTIONS**

**THE MAGAZINE IS NOT
IN A PRINTED FORM BUT
IN PDF FORMAT.**

THANK YOU.

**GARY HESELTINE
EDITOR
UFO MONTHLY.COM**

Roswell 60

The UK's premiere UFO Conference
20th - 21st October 2007

Presenting

Dr Jesse Marcel Jnr.

Don Schmitt

Nick Pope

Michael Hesemann

Malcolm Robinson

Gary Heseltine

Philip Mantle

Russel Callaghan

Venue. The Parkside Hotel & Conference Centre
Pontefract, Nr Wakefield Sat 20th Oct - Sun 21st Oct 2007

BOOK NOW

UFO DATA are proud to announce the first ever visit to the UK by Jesse Marcel Jnr. The only man alive today we know saw wreckage from the alleged 1947 UFO crash. The weekend will celebrate Roswell and the modern era of Ufology.

Seats are selling fast so book now to avoid missing out...

TICKET PRICES

SATURDAY £15.00

SUNDAY £15.00

WEEKEND £25.00

Meet the speakers
dinner and dance
Saturday night
£15.00

*Regular or Vegetarian
menu*

To book visit our website
www.ufodata.co.uk or
make

cheques or PO payable to
UFO DATA and post to
UFO DATA PO BOX 280
LEEDS, LS26 1AN.

Tel 0113 2865566

The Parkside Hotel is situated just off the M62 in West Yorkshire (Junc 32) Rail and Bus services available.

**0113 2865566 07957
223358**

The Parkside Hotel is situated just off the M62 in West Yorkshire (Junc 32) Rail and Bus services Available.

Bookings open 19/08/2007